



FLUID COMPONENTS, INC.

PDLC Series Gauges

4" • Low-Cost Glycerine-Filled Gauges

Features

- 304 Stainless Steel Case & Bezel
- Phosphor Bronze Bourdon Tube
- Bronze 1/4" NPT Connection
- Polycarbonate Lens
- Built-in Snubber
- Range: 15 psi to 10,000 psi
- Dual Scale: psi & bar
- Accuracy: ± 2% FSD
- Temperature Range: -13° to 180°F
- Certificate of Accuracy Available
(see page 14 for details)



Installation Data

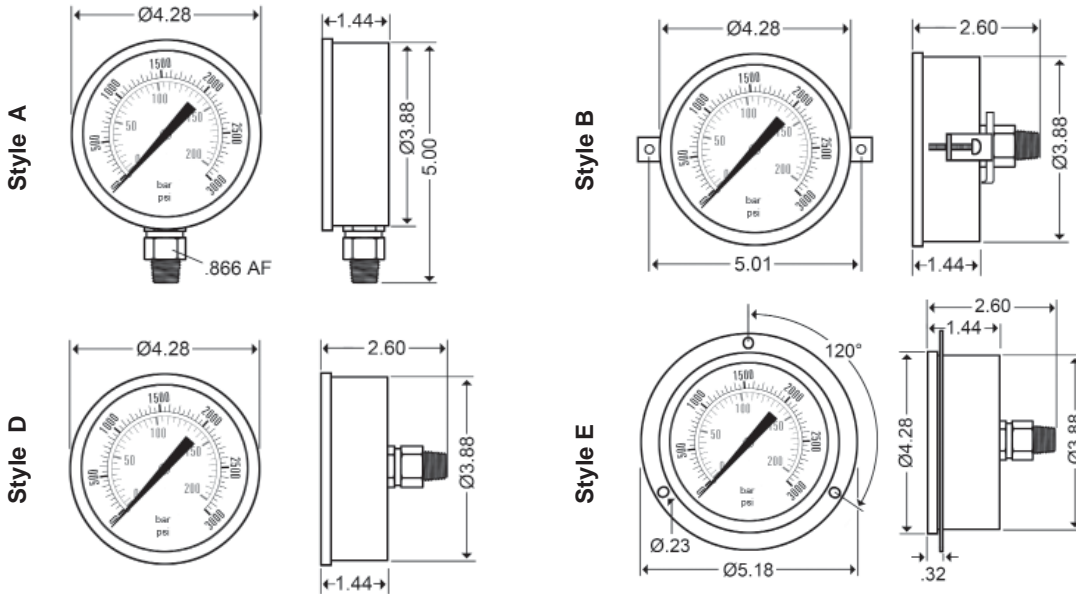

1/4" NPT is standard connection for all PDLC gauges.

Weight (in lbs)			
Style A	Style B	Style D	Style E
1.20	1.45	1.25	1.30

Ordering Example:

Model	Size	Type	Range	Style
PDLC	2	P	070	A

Model	Size	Type	Pressure Range	Style	
PDLC = Low cost, glycerine-filled 4" gauge	2 = 4" dia.	P = Pressure	001 = 15 psi 002 = 30 psi 004 = 60 psi 007 = 100 psi 010 = 160 psi 015 = 200 psi 020 = 300 psi 040 = 600 psi	070 = 1000 psi 100 = 1500 psi 140 = 2000 psi 210 = 3000 psi 280 = 4000 psi 350 = 5000 psi 420 = 6000 psi 700 = 10,000 psi	A = Stem B = Panel Clamp D = Center Back E = Panel Flange

*Some pressure range / mount configurations may require special order.